

PREVEX Preloc 400

EN 274 □

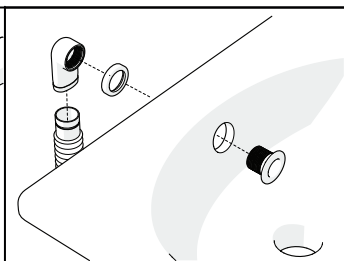

AIP-00019 / A1

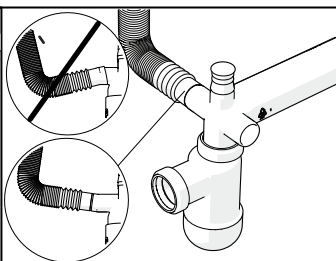
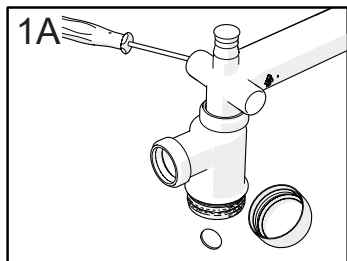
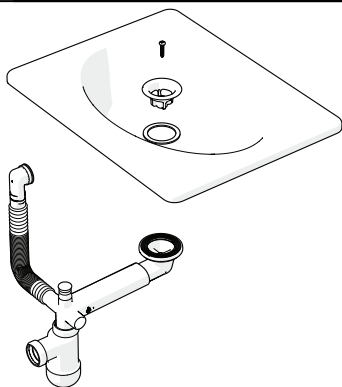
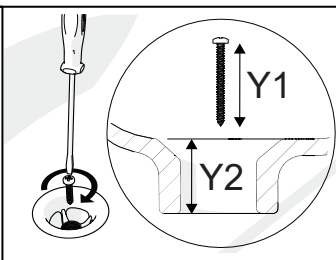
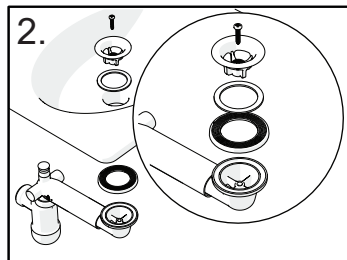

Y1	Y2
25	15-25
32	15-30
45	30-45
50	35-50
60	45-60
80	65-80

AIP-00135 / A2

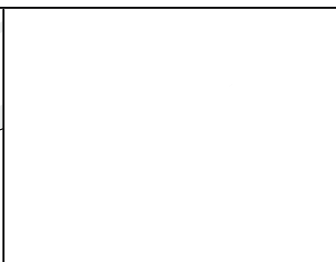
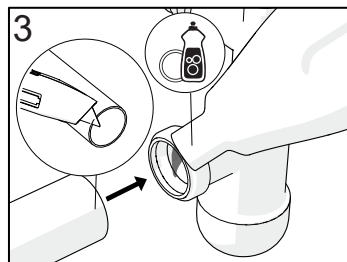

AIP-00020 / A1

4.

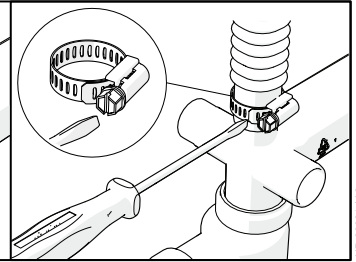
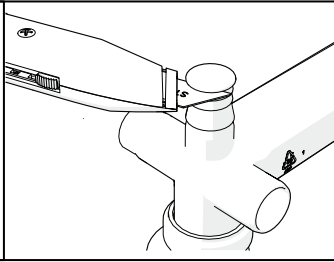

AIP-00021 / A2

i A

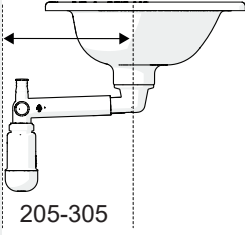

205-305



> 40

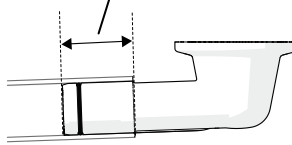

i B

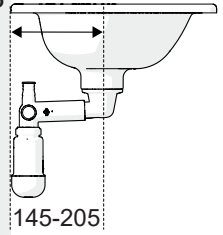

145-205

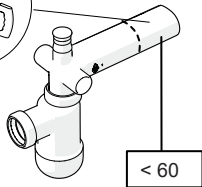
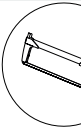

< 60

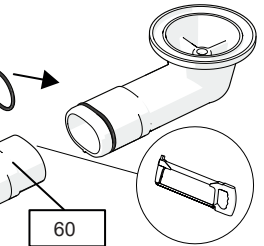
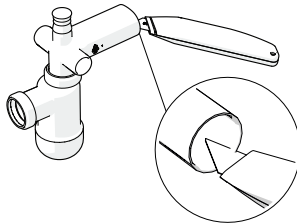

60

AIP-00022 / A1

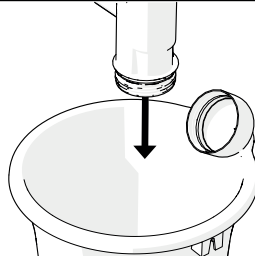
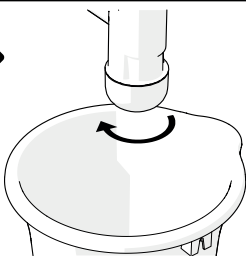

AIP-00023 / A1